

AIR3060

Red LED IR Light
Medium distance / Medium angle

Advanced infrared illuminator to be used in low light or even total darkness locations. Professional and powerful solutions to have light support for night time surveillance or in areas with poor light conditions.

Fully versatile and multiuse light illuminators for indoor or outdoor application.

A perfect combination with Arlotto high resolution network cameras for professional surveillance applications.

- Viewing distance: 70m.
- Viewing HFOV: 80m.
- Beam Angle: 60°
- Waterproof: IP66
- Working temperature -40/55°C.
- 2 stage light intensity
- Energy saving
- Effective heat sink design
- 90% luminous effectiveness
- 50,000 hours lifetime LED



High power LED IR illuminator

Type	High power LED IR illuminator
LED type	30pcs. 2W. Dot matrix IR LED
Wave length	740-850-940nm.
Viewing distance	70 m.
Viewing HFOV (m.)	80 m.
Beam angle	60 °.
Power factor	09-0,98
Voltage	AC85-265V.-DC12-AC24V.
Power consumption	37W. (50% design margin)
Day and night switch	Auto (built in photocell)
Cable	1,3m. Waterproof cable
Mounting	Wall mounting "U" bracket
Working temperature	-40/55°C.
Waterproof level	IP66
Frame color	Black
Frame material	Aluminium
Panel material	High light transmittance toughened glass
Net weight	3,3 Kg.
Dimension	210x213x115,5 mm.

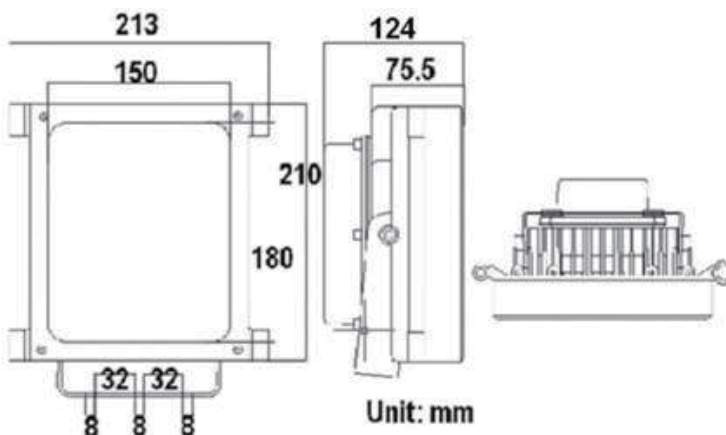

arlotto
The Networking Powerhouse

Arlotto Comnet Inc.

No. 54 Park Avenue 2. Hsinchu Science Park
30075 Hsinchu, Taiwan

Tel:+886-3-5678020 | Fax:+886-3-5678019

email: sales@arlotto.com.tw